

S E R G O

fronty meblowe

FS-1

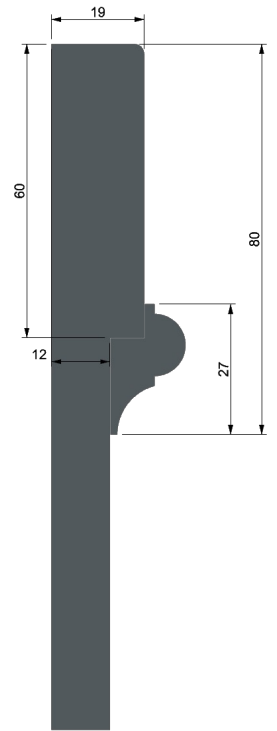

FS-2

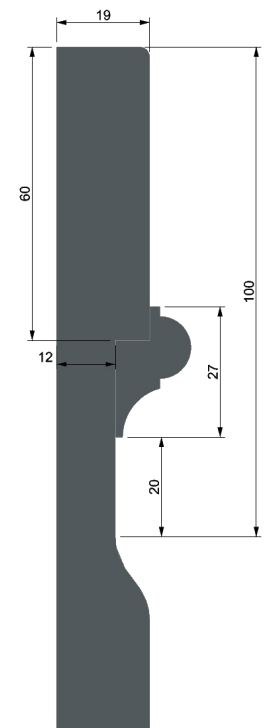

S E R G O

fronty meblowe

FS-3

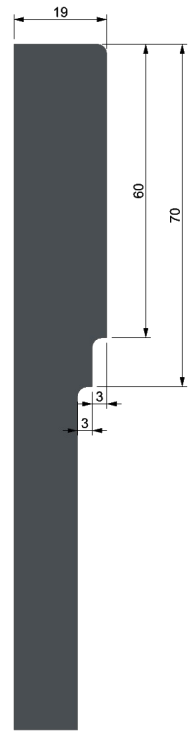

FS-4

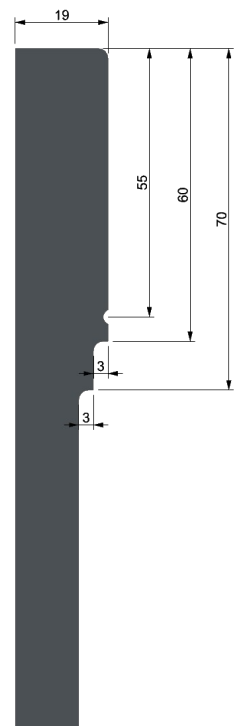

S E R G O

fronty meblowe

FS-5

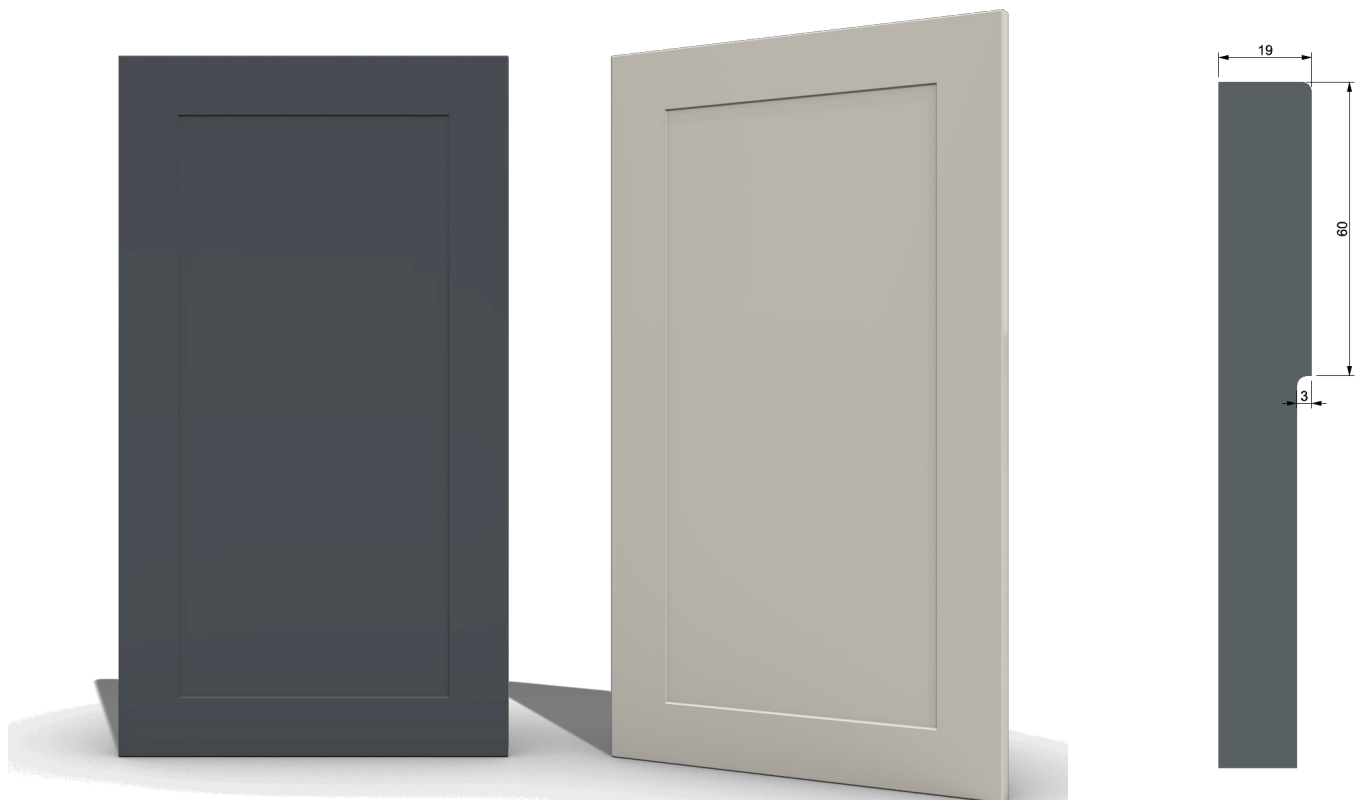

FS-6



S E R G O

fronty meblowe

FS-7

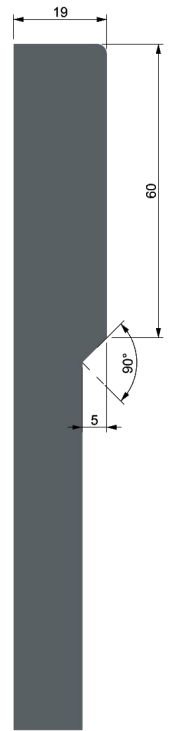
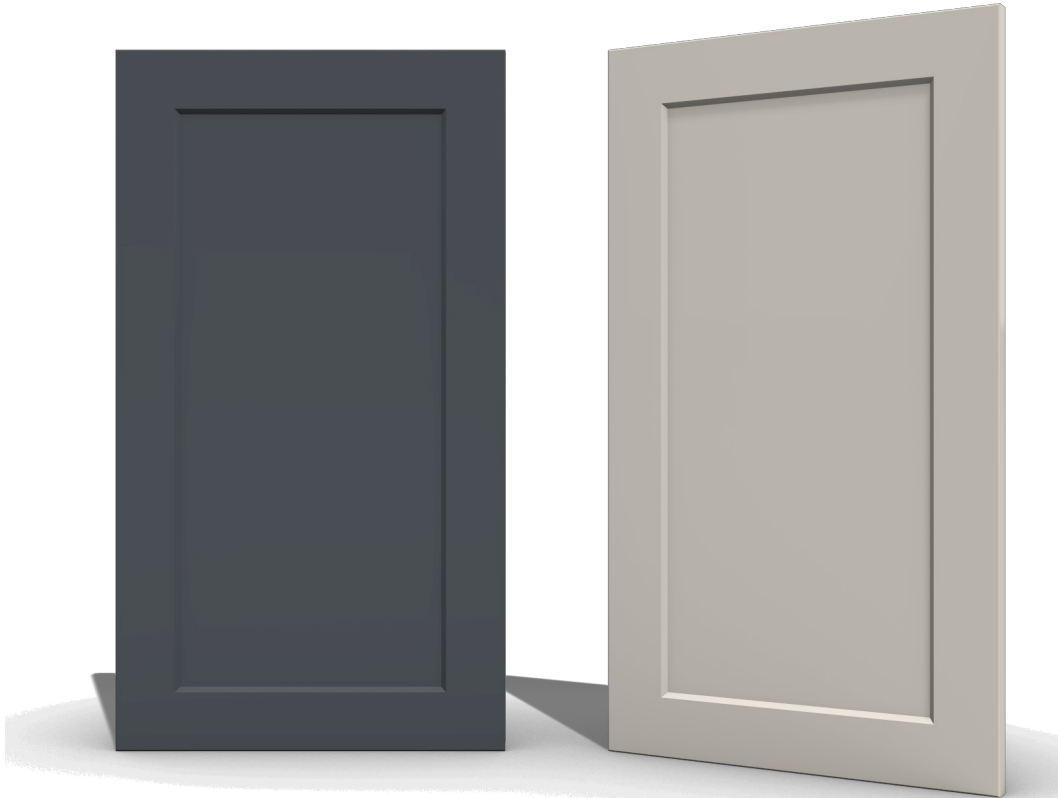

FS-8

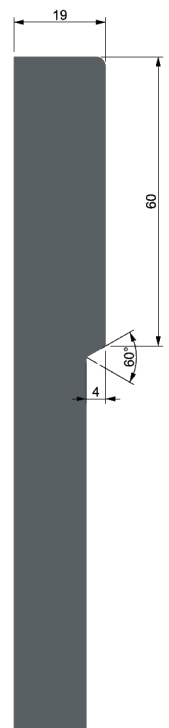

FS-9

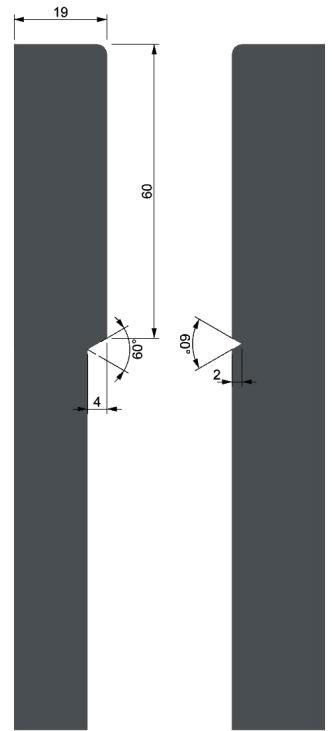

FS-10

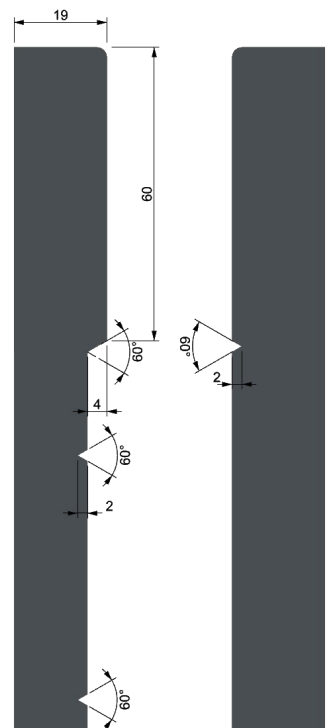

FS-11

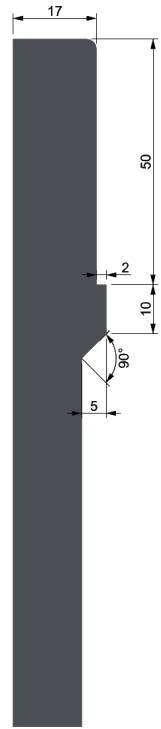

FS-12

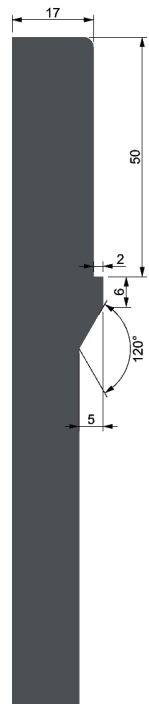

FS-13



FS-14



FS-15

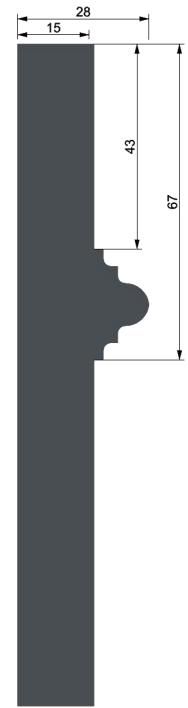

FS-16

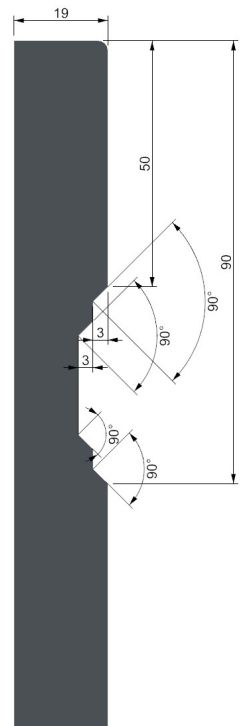

FS-17

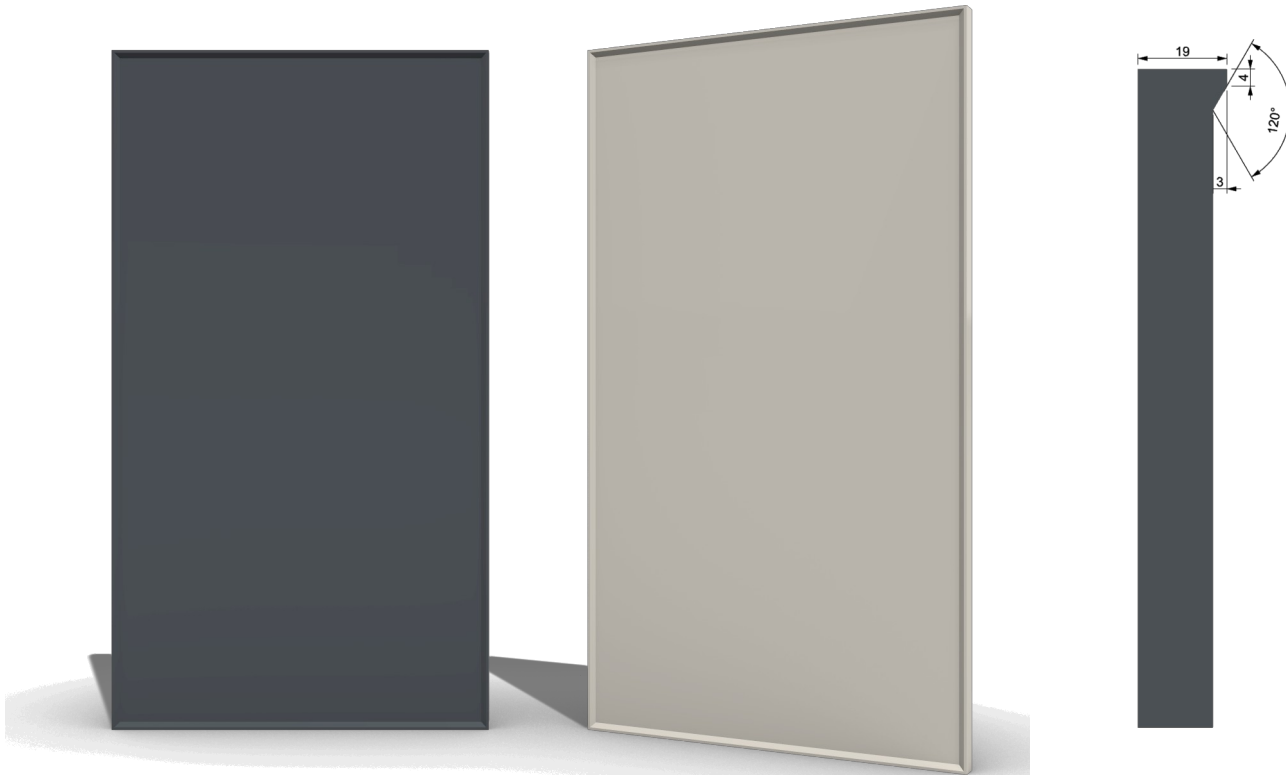

FS-18

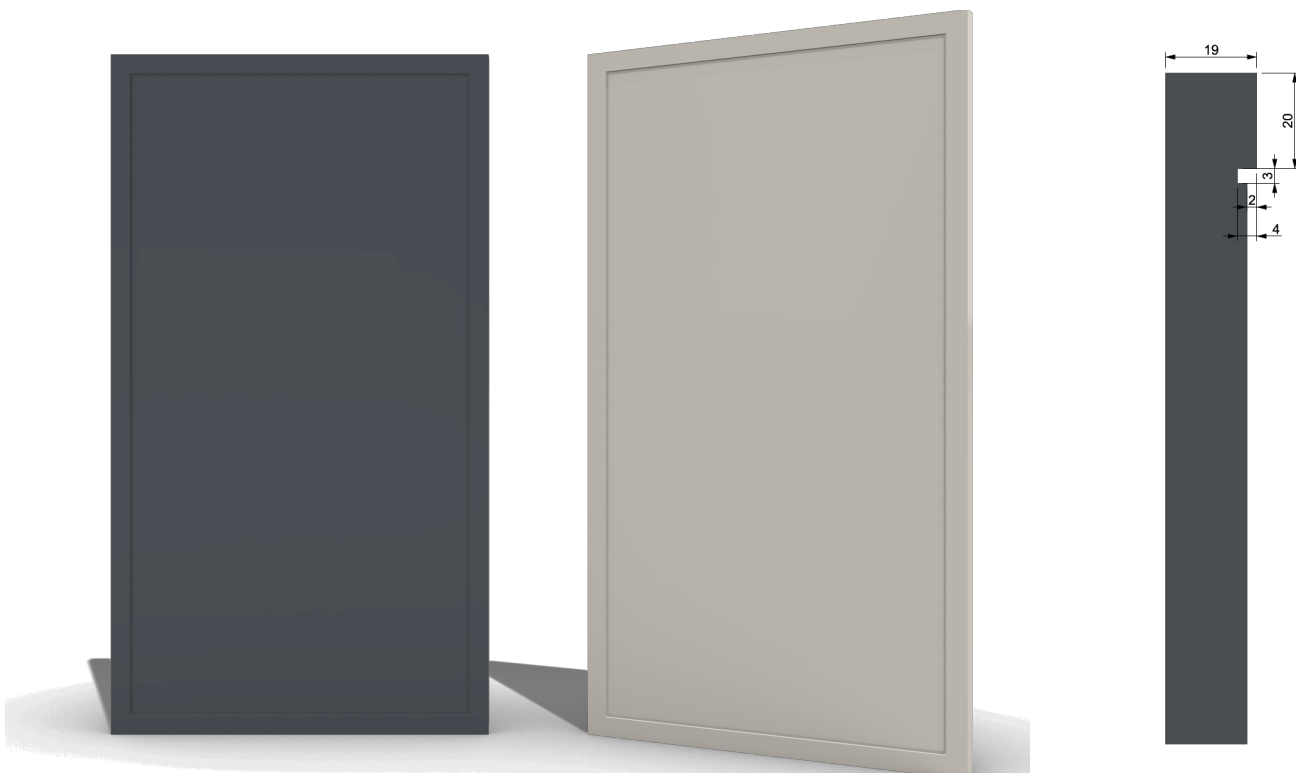

S E R G O

fronty meblowe

W 1

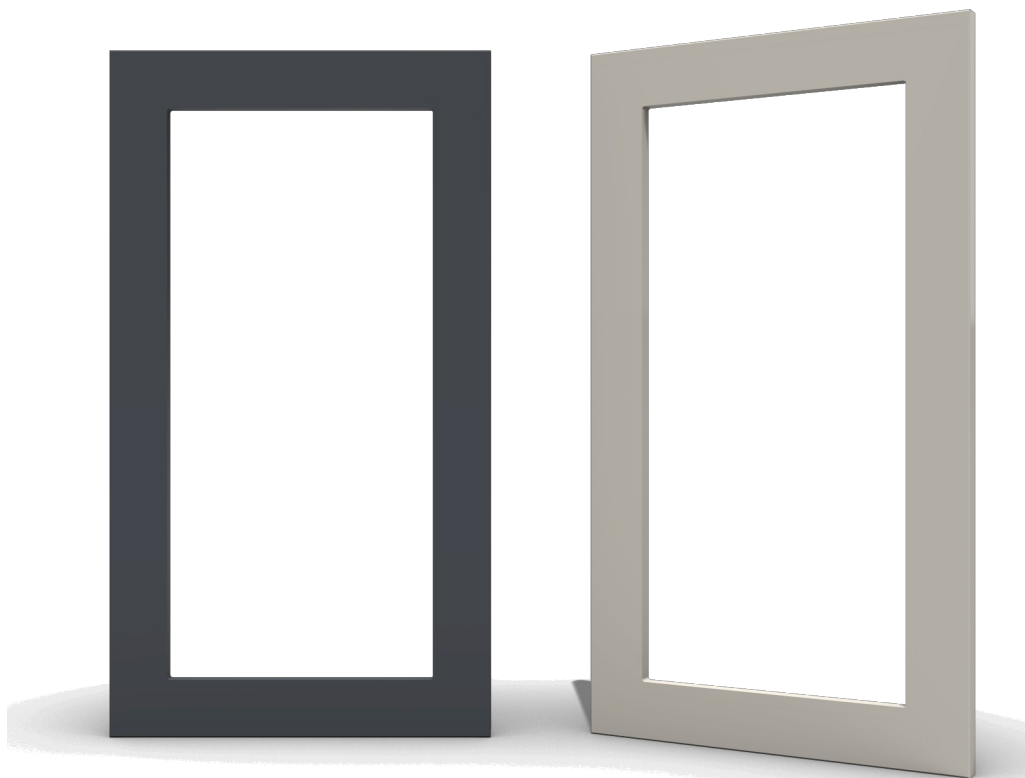

W 2

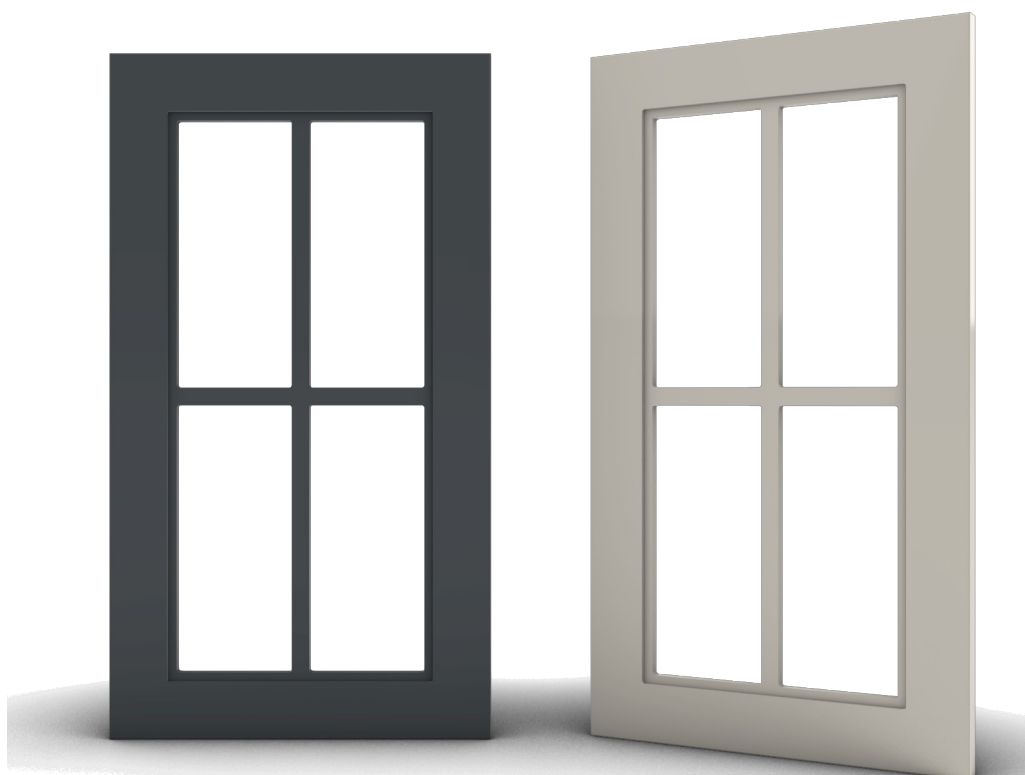

S E R G O

fronty meblowe

W 3

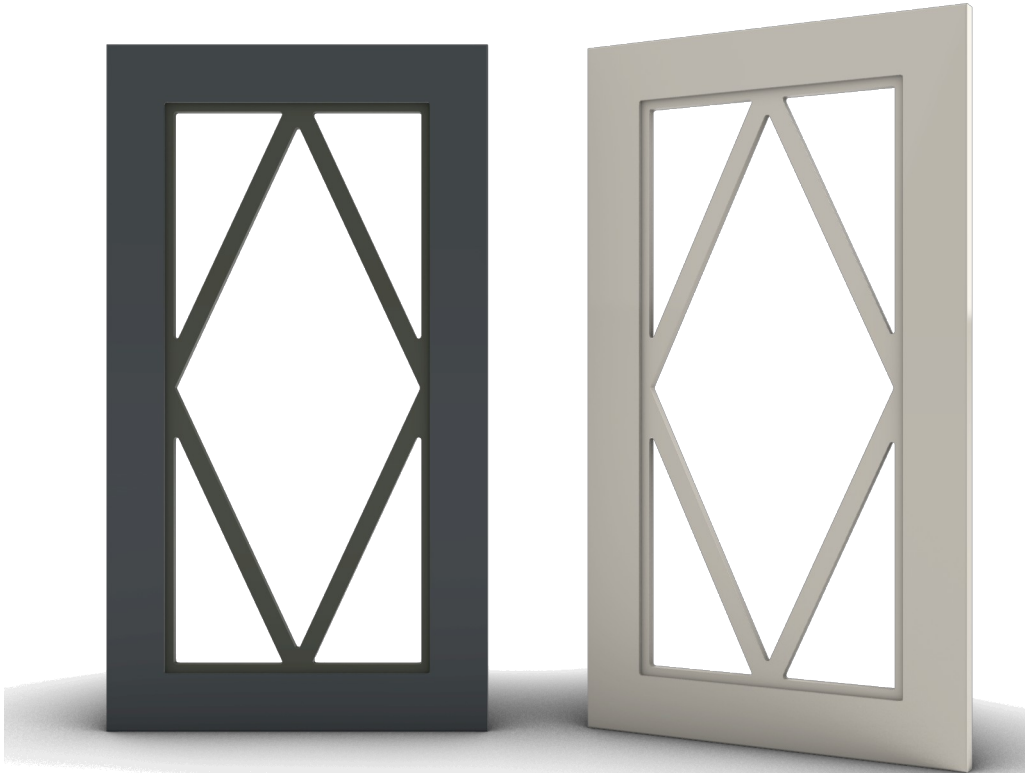

W 4

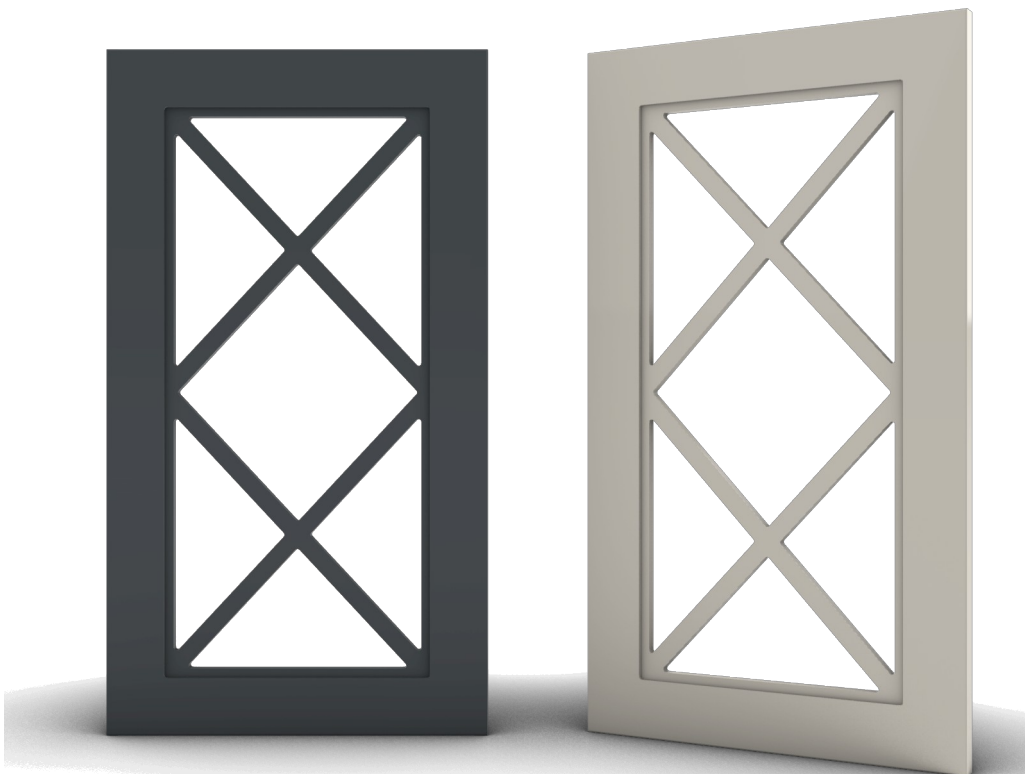

Parametry techniczne wykonywanych frontów

- Fronty wykonujemy na płycie MDF do głębokiego frezowania
- Istnieje możliwość zmiany szerokości ramiaka
- Istnieje możliwość zmiany głębokości frezowania płyciny
- Istnieje możliwość wybrania ramiaka frontu z jednego wzoru a płyciny z drugiego
- Wykonujemy niestandardowe frezowania